

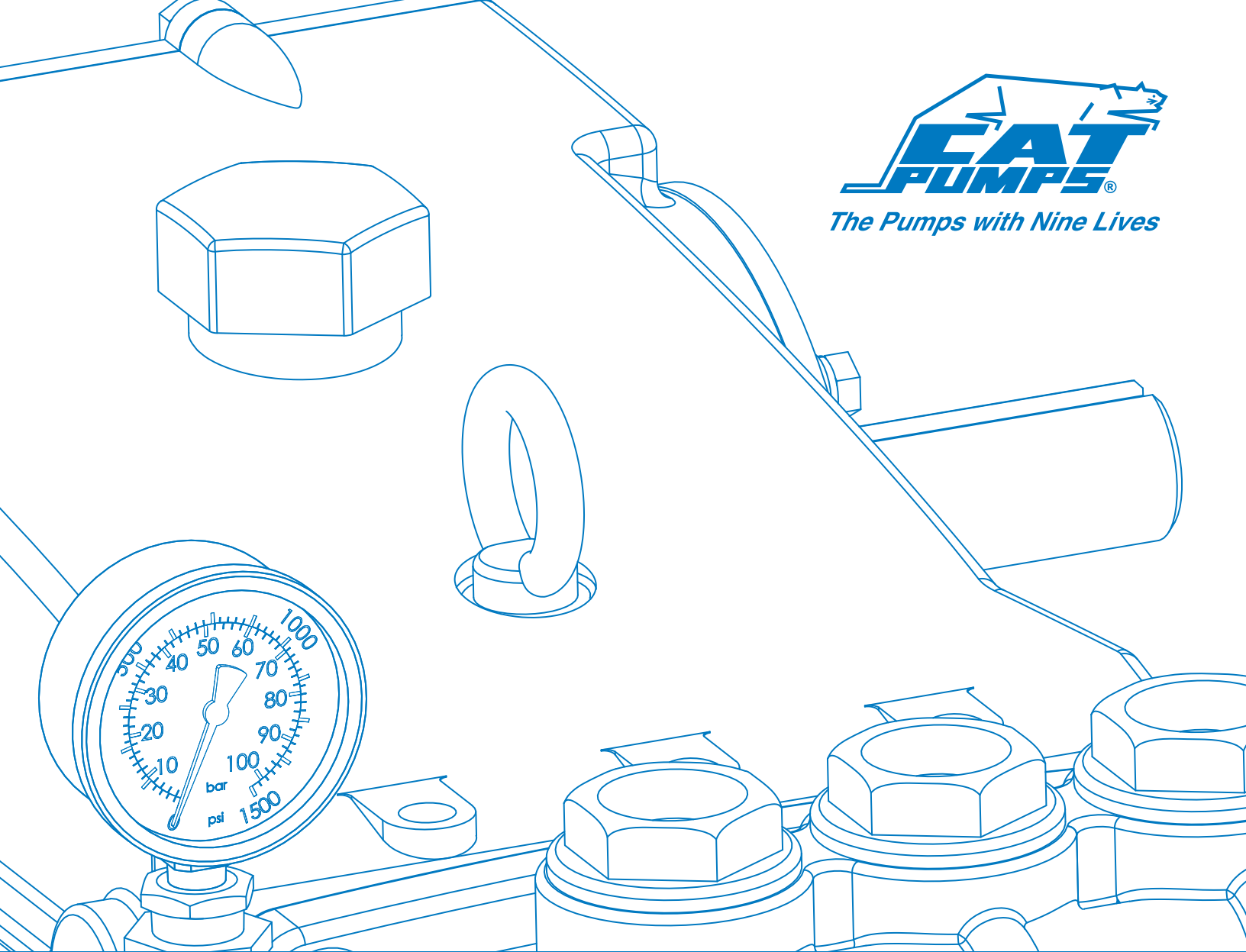

*The Pumps with Nine Lives*



# Pump Catalog

Value focused by exceeding expectations for quality, reliability and support.



# Choose Cat Pumps and Build Your Bottom Line

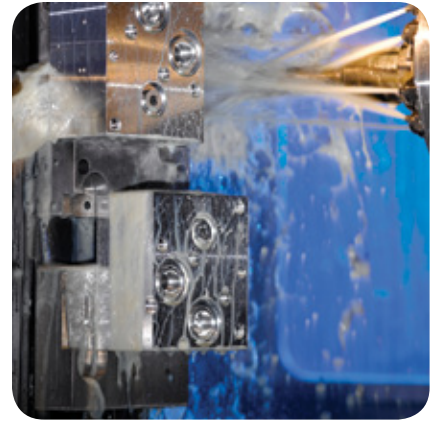

## Durability and Reliability Start Here

Cat Pumps' global mission is to exceed every customer's expectation for quality, reliability, product availability, delivery and technical support. For over four decades this mission has been the foundation of the company's ongoing success.

By providing proven, quality triplex positive displacement pumps, Cat Pumps has earned a reputation for exceptional product durability and reliability. Industries served include commercial cleaning, manufacturing, the process industries, government, military, vehicle cleaning, agriculture, food processing, the misting/cooling/fogging industry, plus many more. Customers select its pumps due to the low-life cycle cost, which provides exceptional value over the life of the system. In fact, Cat Pumps still has pumps running after more than three decades of reliable service. The organization continues to invest in new products and technologies to provide the innovation you have come to expect from Cat Pumps.

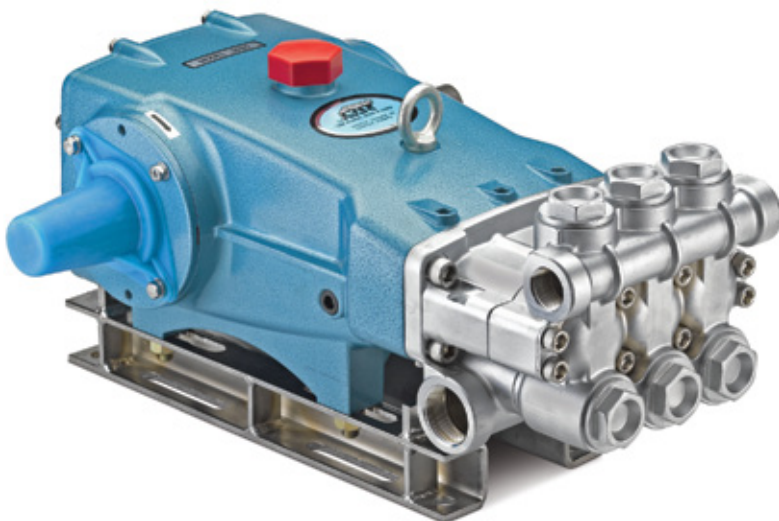

## Product Performance Range:

A wide range of pump options are available, including a variety of products which meet various certifications and directives (i.e., ATEX).

- Flow: 0.13 to 240 gpm (.049 to 908 lpm)
- Pressure: 100 to 10,000 psi (7 to 689 bar)
- RPM: 100 to 3450
- Liquid Temperature: -10° to 240°F (-23° to 116°C)
- Materials: Brass, Nickel Aluminum Bronze, 304 and 316 Stainless Steel, Duplex Stainless Steel
- Drives: Electric, Engine, Hydraulic, Pneumatic



## Developing Strong Relationships

The customer has always been the foundation of Cat Pumps' business success and will continue to be in the years to come. Cat Pumps strives to meet the needs of its customers by doing one simple thing. Listening. Customers expect products that they buy to make a difference in their businesses, and as long as there are challenging pumping applications, there will be a commitment to supply products that answer the call to provide reliability, durability and value.

Today, Cat Pump's products are sold and serviced through hundreds of distributor partners worldwide. The emphasis on customer satisfaction is instilled on an international scale, so you will find them to be a trusted partner that pledges to provide world-class technical support and aftermarket service. Leverage the technical strength of a truly global team for your next high-pressure pumping application.



**Cat Pumps is dedicated to high inventory levels at its Minneapolis and international branch locations. The Minneapolis location has a 99.7% fill rate with over 95% of orders shipped within 24 hours to U.S. and Canadian customers. Distributors stock pumps and parts locally, but also play a vital role in technical and service support.**

# Product Ordering

## Using This Catalog

The plunger and piston pump sections of this catalog are organized by manifold material and flow rate range. Each pump chart has a column titled "Pump Model." The model number in this column represents the standard pump model offering equipped with Buna seals and O-rings.

Standard Buna pump seals and/or O-rings can be changed. Other seal materials will be listed in the "Optional Seals" column of the pump charts. You will need to add a suffix to the standard model number that represents your desired new seal material.

### Optional Seal and O-Ring Configurations

MATERIAL CODE	DESCRIPTION	PUMP MODEL SUFFIX
FPM	Fluorocarbon (Viton®) seals and O-rings	.0110
	Fluorocarbon (Viton®) seals only	.0100
PTFE	Pure Polytetrafluoroethylene (Teflon®) seals and Buna O-rings	.0700
	Pure Polytetrafluoroethylene (Teflon®) seals and FPM O-rings	.0710
IPFE	Pure Polytetrafluoroethylene (Teflon®) seals and Isolast O-rings	.0770
EPDM	Ethylene Propylene Diene Monomer seals and O-rings	.0220
NBRS	Buna-N silicone free seals and O-rings	.6000
STHT	Special Teflon® high temperature low and high pressure seals	.3400
HT	High temperature seal for plunger pump high pressure seals	.3000
	High temperature V-HOT cup for piston pumps	.3000
BNG	Blue-dot (non-greased) Buna-N seals with wicks for piston pumps	.0300
ST4	Special Teflon® high temperature low and high pressure seals with FPM O-rings for 240°F operation.	.4410

Viton® and Teflon® are registered trademarks of DuPont Dow Elastomers.

### Example

Pump model 3535 can be changed from Buna to either FPM or EPDM. To convert pump model 3535 from Buna seals and O-rings to FPM (Viton®), you would add the suffix (.0110) to the standard pump model number (3535.0110). Use this new number when ordering the pump.

PUMP MODEL	MAXIMUM FLOW		MAXIMUM PRESSURE		HORSEPOWER		RPM	DRIVES	OPTIONAL <sup>1</sup> SEALS
	GPM	LPM	PSI	BAR	HP	KW			
<b>BRASS MANIFOLDS WITH BUNA SEALS</b> 6.7 TO 75 GPM (25 TO 284 LPM)									
Note: Models ending in the letter "C" or "K" are flush style pumps. Pumps in italics indicate an optional performance rating. * Intermittent Duty Only.									
3560	25	95	3000	210	51.4	38.3	1450	Belt	FPM
3535	36	136	1200	85	29.7	22.1	800	Belt	FPM, EPDM
3535C	36	136	1200	85	29.7	22.1	800	Belt	FPM, EPDM

<sup>1</sup> Selection of an optional seal requires a suffix addition to the base model number. For more information see page 5.

Cat Pumps configures a number of pumps for special applications and certifications (i.e., ATEX, CO2, others).

Please contact Cat Pumps directly (763-780-5440).



# Plunger Pumps

## ALUMINUM MANIFOLDS



1XP125



1XP125.051  
(with motor)

PUMP <sup>1</sup> MODEL	MAXIMUM FLOW		MAXIMUM PRESSURE		HORSEPOWER		RPM	DRIVES	OPTIONAL SEALS
	GPM	LPM	PSI	BAR	HP	KW			
<b>ALUMINUM MANIFOLDS WITH FPM SEALS 0.50 TO 2.00 GPM (1.89 TO 7.60 LPM)</b>									
1XP050.031	0.50	1.89	800	55	0.33	0.24	1750	Direct - cam shaft	Contact Cat Pumps
1XP075.031	0.75	2.84	650	45	0.33	0.24	1750	Direct - cam shaft	Contact Cat Pumps
1XP085.031	0.85	3.22	600	41	0.33	0.24	1750	Direct - cam shaft	Contact Cat Pumps
1XP100.031	1.00	3.78	500	34	0.33	0.24	1750	Direct - cam shaft	Contact Cat Pumps
1XP125.031	1.25	4.73	400	27.5	0.33	0.24	1750	Direct - cam shaft	Contact Cat Pumps
1XP150.031	1.50	5.68	325	22	0.33	0.24	1750	Direct - cam shaft	Contact Cat Pumps
1XP200.031	2.00	7.56	250	17	0.33	0.24	1750	Direct - cam shaft	Contact Cat Pumps
1XP085.051	0.85	3.22	800	55	0.50	0.37	1750	Direct - cam shaft	Contact Cat Pumps
1XP100.051	1.00	3.78	800	55	0.50	0.37	1750	Direct - cam shaft	Contact Cat Pumps
1XP125.051	1.25	4.73	600	41	0.50	0.37	1750	Direct - cam shaft	Contact Cat Pumps
1XP150.051	1.50	5.68	500	34	0.50	0.37	1750	Direct - cam shaft	Contact Cat Pumps
1XP200.051	2.00	7.56	400	27.5	0.50	0.37	1750	Direct - cam shaft	Contact Cat Pumps
1XP125.071	1.25	4.73	800	55	0.75	0.55	1750	Direct - cam shaft	Contact Cat Pumps
1XP150.071	1.50	5.68	700	48	0.75	0.55	1750	Direct - cam shaft	Contact Cat Pumps
1XP200.071	2.00	7.56	500	34	0.75	0.55	1750	Direct - cam shaft	Contact Cat Pumps

<sup>1</sup> Part model includes pump and motor.

### Industry Leading Customer Service

Cat Pumps knowledgeable and experienced customer service team provides assistance with order information as well as technical assistance in product selection, installation, maintenance support, pump repair and general system troubleshooting.

Live support available M – F, 7:30 a.m. to 5:00 p.m. CST at 763-780-5440.

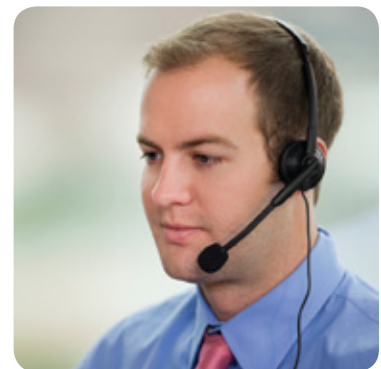

# Plunger Pumps

## BRASS MANIFOLDS

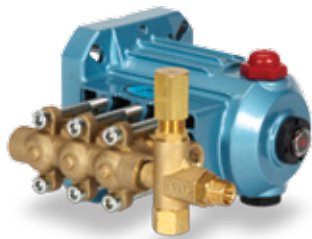

2SF20ES



3CP1130  
(Rails and shaft protector sold separately)



2DX30GS

PUMP MODEL	MAXIMUM FLOW		MAXIMUM PRESSURE		HORSEPOWER		RPM	DRIVES	OPTIONAL <sup>1</sup> SEALS
	GPM	LPM	PSI	BAR	HP	KW			
<b>BRASS MANIFOLDS WITH BUNA SEALS 0.13 TO 2.85 GPM (0.49 TO 10.8 LPM)</b>									
1CX013ELSD251 <sup>2</sup>	0.13	0.49	1000	70	0.12	0.09	1725	Hollow shaft-electric	Contact Cat Pumps
1CX025ELSD251 <sup>2</sup>	0.25	0.95	1000	70	0.24	0.18	1725	Hollow shaft-electric	Contact Cat Pumps
1CX05ELSD501 <sup>2</sup>	0.5	1.89	1000	70	0.47	0.35	1725	Hollow shaft-electric	Contact Cat Pumps
2DX05ELS.MIST	0.5	1.89	2000	140	0.68	0.51	1725	Hollow shaft-electric	Contact Cat Pumps
2SF10ES	1	3.8	2000	140	1.4	1	3450	Hollow shaft-electric	FPM, EPDM, HT
2DX15ES.MIST	1.5	5.7	2000	140	2	1.5	3450	Hollow shaft-electric	Contact Cat Pumps
2DX20ES	2	7.6	2000	140	2.7	2	3450	Hollow shaft-electric	Contact Cat Pumps
2DX20ES.MIST	2	7.6	2000	140	2.7	2	3450	Hollow shaft-electric	Contact Cat Pumps
2SF20ES	2	7.6	2000	140	2.7	2	3450	Hollow shaft-electric	FPM, EPDM, HT
2SF20ES	2	7.6	2000	140	2.7	2	3450	Hollow shaft-electric	FPM, HT
2SF22ELS	2.2	8.3	2000	140	3	2.2	1725	Hollow shaft-electric	FPM, EPDM, HT
2SF22ES	2.2	8.3	2000	140	3	2.2	3450	Hollow shaft-electric	FPM, EPDM, HT
2SF22ES	2.2	8.3	2000	140	3	2.2	3450	Hollow shaft-electric	FPM, HT
230	2.3	8.7	1500	105	2.4	1.8	1725	Solid shaft, Belt, Bell, Clutch	FPM, EPDM, IPFE, STHT, HT
3CP1130	2.4	9	2200	155	3.6	2.7	1725	Solid shaft, Belt, Bell, Clutch	FPM, EPDM, STHT, HT, ST4
4DNX25GSI	2.5	9.5	2850	196	4.9	3.7	3450	Hollow shaft-gas	Contact Cat Pumps
2DX27ES.MIST	2.7	10.2	2000	140	3.7	2.8	3450	Hollow shaft-electric	Contact Cat Pumps
4DNX27GSI	2.7	10.2	2850	196	5.3	4.0	3450	Hollow shaft-gas	Contact Cat Pumps
2SF29ELS	2.85	10.8	1500	105	2.9	2.2	1725	Hollow shaft-electric	FPM, EPDM, HT

<sup>1</sup> Selection of an optional seal requires a suffix addition to the base model number. For more information see page 4.

<sup>2</sup> Part number includes pump and motor.

“We find Cat Pumps to be a durable, robust design and our maintenance team is very impressed with the minimal service. Cat Pumps provides a strong technical support team, as well as, their web based support.”

Pete Divone • Director, Process Engineering • Unilever R&D

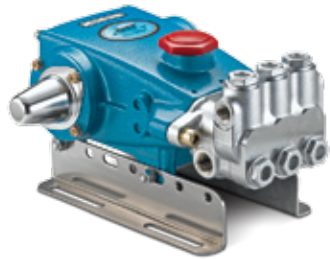

310  
(Rails and shaft protector sold separately)



5CP2120W  
(Rails and shaft protector sold separately)



66DX40G11

PUMP MODEL	MAXIMUM FLOW		MAXIMUM PRESSURE		HORSEPOWER		RPM	DRIVES	OPTIONAL SEALS
	GPM	LPM	PSI	BAR	HP	KW			
<b>BRASS MANIFOLDS WITH BUNA SEALS 3 TO 4 GPM (11.4 TO 15 LPM)</b>									
2DX30ES.MIST	3	11.4	1500	105	3.1	2.3	3450	Hollow shaft-electric	Contact Cat Pumps
2SF30ES	3	11.4	1500	105	3.1	2.3	3450	Hollow shaft-electric	FPM, EPDM, HT
2SFX30ES	3	11.4	1500	105	3.1	2.3	3450	Hollow shaft-gas	FPM, HT
2SF30GS	3	11.4	2000	140	4.1	3.1	3450	Hollow shaft-gas	FPM, EPDM, HT
2SF30GES	3	11.4	2000	140	4.1	3.1	3450	Hollow shaft-electric	FPM, EPDM, HT
2SFX30GS	3	11.4	2000	140	4.1	3.1	3450	Hollow shaft-gas	FPM, HT
2SFX30GZ	3	11.4	2500	175	5.1	3.8	3450	Hollow shaft-gas	FPM, HT
3DX30GSI	3	11.4	2500	175	5.1	3.8	3450	Hollow shaft-gas	Contact Cat Pumps
3SPX30G11	3	11.4	3000	210	6.2	4.6	3450	Hollow shaft-gas	Contact Cat Pumps
66DX30G11	3	11.4	4000	275	8.2	6.1	3400	Hollow shaft-gas	Contact Cat Pumps
2DX30GS	3.1	11.7	2000	140	4.2	3.1	3450	Hollow shaft-gas	Contact Cat Pumps
270	3.5	13.2	1500	105	3.6	2.7	1420	Solid shaft, Belt, Bell, Clutch	FPM, EPDM, IPFE, STHT, HT
2SF35ES	3.5	13.2	1500	105	3.6	2.7	3450	Hollow shaft-electric	FPM, EPDM, HT
2SF35GS	3.5	13.2	2000	140	4.8	3.6	3450	Hollow shaft-gas	FPM, EPDM, HT
2SF35GES	3.5	13.2	2000	140	4.8	3.6	3450	Hollow shaft-electric	FPM, EPDM, HT
3CP1120G	3.5	13.2	2200	155	5.3	4.0	3600	Gearbox	FPM, EPDM, STHT, HT
5CP3110CSS	3.6	13.6	3500	245	8.6	6.4	1750	Solid shaft, Belt, Bell, Clutch	FPM, EPDM, STHT, ST
3SPX35GEI	3.5	13.2	2500	175	6	4.5	3450	Hollow shaft-electric	Contact Cat Pumps
4SF35GS1	3.5	13.2	3500	245	8.4	6.3	3200	Hollow shaft-gas	Contact Cat Pumps
66DX35G11	3.5	13.2	4000	275	9.6	7.2	3400	Hollow shaft-gas	Contact Cat Pumps
240	3.6	13.6	1200	85	3	2.2	1725	Solid shaft, Belt, Bell, Clutch	FPM, EPDM, IPFE, STHT, HT
3CP1140	3.6	13.6	2200	155	5.4	4	1725	Solid shaft, Belt, Bell, Clutch	FPM, EPDM, STHT, HT, ST4
340	4	15	1800	125	5	3.7	1725	Solid shaft, Belt, Bell, Clutch	FPM, EPDM, IPFE, HT
340B	4	15	1800	125	5	3.7	1725	Solid shaft, Belt, Bell, Clutch	FPM, EPDM, IPFE, HT
340S	4	15	1800	125	5	3.7	1725	Solid shaft, Belt, Bell, Clutch	FPM, EPDM, IPFE, HT
310	4	15	2200	155	6	4.5	950	Belt, Clutch	FPM, EPDM, IPFE, HT
310B	4	15	2200	155	6	4.5	950	Belt, Clutch	FPM, EPDM, IPFE, HT
310S	4	15	2200	155	6	4.5	950	Belt, Clutch	FPM, EPDM, IPFE, HT
5CP2120B	4	15	2500	175	6.9	5.1	950	Belt, Clutch	FPM, EPDM, STHT, HT, ST4
5CP2120W	4	15	2500	175	6.9	5.1	950	Belt, Clutch	FPM, EPDM, STHT, HT, ST4
5CP2140B	4	15	2500	175	6.9	5.1	1725	Solid shaft, Belt, Bell, Clutch	FPM, EPDM, STHT, HT, ST4
5CP2140WCS	4	15	2500	175	6.9	5.1	1725	Solid shaft, Belt, Bell, Clutch	FPM, EPDM, STHT, HT, ST4
4SF40ELS	4	15	3500	245	9.6	7.2	1725	Hollow shaft-electric	Contact Cat Pumps
4SF40GS1	4	15	3500	245	9.6	7.2	3200	Hollow shaft-electric	Contact Cat Pumps
66DX40G11	4	15	4000	275	11	8.2	3400	Hollow shaft-gas	Contact Cat Pumps

<sup>1</sup> Selection of an optional seal requires a suffix addition to the base model number. For more information see page 4.

# Plunger Pumps

## BRASS MANIFOLDS



45G1



550  
(Rails and shaft protector sold separately)

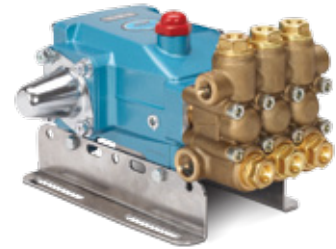

5CP3120  
(Rails and shaft protector sold separately)

PUMP MODEL	MAXIMUM FLOW		MAXIMUM PRESSURE		HORSEPOWER		RPM	DRIVES	OPTIONAL <sup>1</sup> SEALS
	GPM	LPM	PSI	BAR	HP	KW			
<b>BRASS MANIFOLDS WITH BUNA SEALS 4.2 TO 6 GPM (15.9 TO 23 LPM)</b>									
Note: Pumps in <i>italics</i> indicate an optional performance rating.									
270	4.2	15.9	1000	70	2.9	2.2	1725	Solid shaft, Belt, Bell, Clutch	FPM, EPDM, IPFE, STHT, HT
3CP1120	4.2	15.9	2200	155	6.3	4.7	1725	Solid shaft, Belt, Bell, Clutch	FPM, EPDM, STHT, HT, ST4
5CP3160CSS	4.3	16.3	3500	245	10.3	7.7	1750	Solid shaft, Belt, Bell, Clutch	FPM, EPDM, STHT, ST
4SF45ELS	4.5	17	3000	210	9.2	6.9	1725	Hollow shaft-electric	Contact Cat Pumps
4SF45GS1	4.5	17	3000	210	9.2	6.9	3200	Hollow shaft-gas	Contact Cat Pumps
45	4.5	17	3500	245	10.8	8	1645	Belt, Clutch	FPM, HT
45G1	4.5	17	3500	245	10.8	8	3353	Gearbox	FPM, HT
5CP3120	4.5	17	3500	245	10.8	8	1645	Belt, Bell, Clutch	FPM, EPDM, STHT, HT
5CP3120CSSG1	4.5	17	3500	245	10.8	8	3353	Gearbox	FPM, EPDM, STHT, HT
60G1	4.5	17	4000	275	12.3	9.2	3200	Gearbox	FPM, HT
57	4.5	17	4000	275	12.3	9.2	1285	Belt, Clutch	FPM, HT
700	4.5	17	5000	345	15.4	11.5	1700	Belt, Clutch	FPM
700G1	4.5	17	5000	345	15.4	11.5	3465	Gearbox	FPM
5CP3120CSS	4.8	18.2	3000	210	9.9	7.4	1750	Solid shaft, Belt, Bell, Clutch	FPM, EPDM, STHT, HT
350	5	19	1500	105	5.1	3.8	1725	Solid shaft, Belt, Bell, Clutch	FPM, EPDM, IPFE, HT
350B	5	19	1500	105	5.1	3.8	1725	Solid shaft, Belt, Bell, Clutch	FPM, EPDM, IPFE, HT
350S	5	19	1500	105	5.1	3.8	1725	Solid shaft, Belt, Bell, Clutch	FPM, EPDM, IPFE, HT
5CP2150B	5	19	2000	140	6.9	5.1	1725	Solid shaft, Belt, Bell, Clutch	FPM, EPDM, STHT, HT, ST4
5CP2150W	5	19	2000	140	6.9	5.1	1725	Solid shaft, Belt, Bell, Clutch	FPM, EPDM, STHT, HT, ST4
530	5	19	2500	175	8.6	6.4	1100	Belt, Clutch	FPM
550	5	19	3000	210	10.3	7.7	1415	Belt, Clutch	FPM, HT
4SF50ELS	5	19	3000	210	10.3	7.7	1725	Hollow shaft-electric	Contact Cat Pumps
4SF50GS1	5	19	3000	210	10.3	7.7	3200	Hollow shaft-gas	Contact Cat Pumps
5CP5120	5	19	3000	210	10.3	7.7	1415	Belt, Clutch	FPM, EPDM, STHT, HT
56	5.5	21	3500	245	13.2	9.8	1210	Belt, Clutch	FPM, HT
59G1	5.5	21	3500	245	13.2	9.8	3200	Gearbox	FPM, HT
5CP5140	5.5	21	3500	245	13.2	9.8	1500	Belt, Clutch	FPM, EPDM, STHT, HT
5CP5140CSSG1	5.5	21	3500	245	13.2	9.8	1570	Gearbox	FPM, EPDM, STHT, HT
5CP6120	6	23	1600	110	10.3	7.7	1750	Belt, Clutch	FPM, EPDM, STHT, HT, ST4
5CP5120	6	23	2500	175	10.3	7.7	1750	Solid shaft, Belt, Bell, Clutch	FPM, EPDM, STHT, HT

<sup>1</sup> Selection of an optional seal requires a suffix addition to the base model number. For more information see page 4.





1050  
(Rails and shaft protector sold separately)



3535  
(Rails sold separately)



6760

PUMP MODEL	MAXIMUM FLOW		MAXIMUM PRESSURE		HORSEPOWER		RPM	DRIVES	OPTIONAL <sup>1</sup> SEALS
	GPM	LPM	PSI	BAR	HP	KW			
<b>BRASS MANIFOLDS WITH BUNA SEALS 6.7 TO 75 GPM (25 TO 284 LPM)</b>									
Note: Models ending in the letter "C" or "K" are flush style pumps. Pumps in <i>italics</i> indicate an optional performance rating. * Intermittent Duty Only.									
5CP6120CSSG1	6.7	25	1600	110	7.3	5.4	3200	Gearbox	FPM, EPDM, STHT, HT, ST4
650	7	26	3000	210	14.4	10.7	1000	Belt, Clutch	FPM, EPDM
<i>5CP6120</i>	<i>7.4</i>	<i>28</i>	<i>1200</i>	<i>85</i>	<i>6.1</i>	<i>4.5</i>	<i>1750</i>	<i>Bell, Belt, Clutch</i>	<i>FPM, EPDM, STHT, HT, ST4</i>
56G1	8	30	1800	125	9.9	7.4	3600	Gearbox	FPM, HT
1560	8	30	4000	275	21.9	16.3	1140	Belt, Clutch	FPM
5CP6190G1	8.7	33	1200	85	7.2	5.3	1570	Gearbox	FPM, EPDM
5CP6190	9.7	37	1200	85	7.9	5.9	1750	Solid shaft, Belt, Bell, Clutch	FPM, EPDM
1050	10	38	2200	155	15.1	11.3	958	Belt, Clutch	FPM, EPDM, STHT, IPFE, ST4, PTFE
7CP6110G1	10	38	2000	140	13.7	10.2	1667	Gearbox	FPM, EPDM, STHT
660	10	38	3000	210	20.6	15.4	1429	Belt, Clutch	FPM, EPDM, STHT, IPFE
7CP6110	10.5	40	2000	140	14.4	10.7	1750	Solid shaft, Belt, Bell, Clutch	FPM, EPDM, STHT
7CP6170	10.5	40	2000	140	14.4	10.7	1450	Belt, Clutch	FPM, EPDM, STHT
<i>1050</i>	<i>12</i>	<i>45</i>	<i>1800</i>	<i>125</i>	<i>14.8</i>	<i>11</i>	<i>1150</i>	<i>Belt, Clutch</i>	<i>FPM, EPDM, STHT, IPFE, ST4</i>
7CP6170G1	12	45	2000	140	16.4	12.3	3400	Gearbox	FPM, EPDM, STHT
1530	15.6	59	1500	105	16	11.9	1450	Belt, Clutch	FPM, EPDM, IPFE
1540E	18	68	1200	85	14.8	11	1100	Belt, Clutch	ST4
2510	20	76	2000	140	27.5	20.5	1450	Belt	FPM, IPFE
3560	20	76	4000	275	54.8	40.9	1160	Belt	FPM
<i>2530</i>	<i>21</i>	<i>79</i>	<i>1200</i>	<i>85</i>	<i>17.3</i>	<i>12.9</i>	<i>860</i>	<i>Belt</i>	<i>FPM, EPDM, IPFE, ST4</i>
<i>2530E</i>	<i>21</i>	<i>79</i>	<i>1200</i>	<i>85</i>	<i>17.3</i>	<i>12.9</i>	<i>860</i>	<i>Belt</i>	<i>FPM, EPDM, IPFE, ST4</i>
3520	23	87	2000	140	31.6	23.6	800	Belt	FPM, EPDM, IPFE
3520C	23	87	2000	140	31.6	23.6	800	Belt	FPM, EPDM, IPFE
2530	25	95	1000	70	17.1	12.8	1025	Belt	FPM, EPDM, IPFE, ST4
2530E	25	95	1000	70	17.1	12.8	1025	Belt	FPM, EPDM, IPFE, ST4
<i>3560</i>	<i>25</i>	<i>95</i>	<i>3000</i>	<i>210</i>	<i>51.4</i>	<i>38.3</i>	<i>1450</i>	<i>Belt</i>	<i>FPM</i>
3535	36	136	1200	85	29.7	22.1	800	Belt	FPM, EPDM
3535C	36	136	1200	85	29.7	22.1	800	Belt	FPM, EPDM
3545	45	170	1000	70	30.9	23.0	765	Belt	FPM, EPDM
3545HS*	45	170	1200	85	37.0	27.6	765	Belt	FPM, EPDM
6760	60	227	1200	85	49.4	36.8	520	Belt	FPM, EPDM
6775	75	284	1200	85	61.6	45.9	650	Belt	FPM, EPDM

<sup>1</sup> Selection of an optional seal requires a suffix addition to the base model number. For more information see page 4.

Check out [catpumps.com](http://catpumps.com) for all of your pumping needs.

# Plunger Pumps

## NICKEL ALUMINUM BRONZE MANIFOLDS

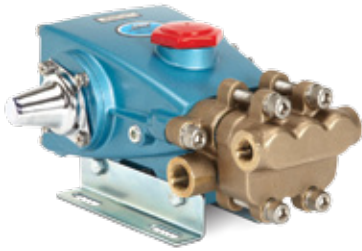

277  
(Rails and shaft protector sold separately)



2537  
(Rails and shaft protector sold separately)



6767

PUMP MODEL	MAXIMUM FLOW		MAXIMUM PRESSURE		HORSEPOWER		RPM	DRIVES	OPTIONAL <sup>1</sup> SEALS
	GPM	LPM	PSI	BAR	HP	KW			
<b>NICKEL ALUMINUM BRONZE MANIFOLDS WITH BUNA SEALS 2.3 TO 75 GPM (8.7 TO 284 LPM)</b>									
Note: Pumps in <i>italics</i> indicate an optional performance rating. * Intermittent Duty Only.									
237	2.3	8.7	1500	105	2.4	1.8	1725	Solid shaft, Belt, Bell, Clutch	FPM, EPDM, STHT, HT, IPFE
277	3.5	13.2	1500	105	3.6	2.7	1420	Belt, Bell, Clutch	FPM, EPDM, STHT, HT, IPFE
247	3.6	13.6	1200	85	3	2.2	1725	Solid shaft, Belt, Bell, Clutch	FPM, EPDM, STHT, HT, IPFE
347	4	15	1800	125	5	3.7	1725	Solid shaft, Belt, Bell, Clutch	FPM, EPDM, HT, IPFE
317	4	15	2200	155	6	4.5	950	Belt, Clutch	FPM, EPDM, HT, IPFE
357	5	19	1500	105	5.1	3.8	1725	Solid shaft, Belt, Bell, Clutch	FPM, EPDM, HT, IPFE
3507	9	34	5000	345	30.8	23	824	Belt	FPM
1057	10	38	2200	155	15.1	11.3	958	Belt, Clutch	FPM, EPDM, STHT, IPFE, ST4
<i>1057</i>	<i>12</i>	<i>45</i>	<i>1800</i>	<i>125</i>	<i>14.8</i>	<i>11</i>	<i>1150</i>	<i>Belt, Clutch</i>	<i>FPM, EPDM, STHT, IPFE, ST4</i>
3517	14	53	3000	210	28.8	21.5	800	Belt	FPM, EPDM
3527HS*	20	76	2300	159	31.5	23.5	700	Belt	FPM, EPDM, IPFE
2537	21	79	1200	85	17.3	12.9	860	Belt	FPM, EPDM, IPFE, ST4
3527	23	87	2000	140	31.6	23.6	800	Belt	FPM, EPDM, IPFE
3537	36	136	1200	85	29.7	22.1	800	Belt	FPM, EPDM
3537HS*	40	151	2000	140	54.8	40.9	888	Belt	FPM, EPDM
6747	48	182	2000	140	65.8	49.1	615	Belt	FPM, EPDM
6767	60	227	1200	85	49.4	36.8	520	Belt	FPM, EPDM
6777	75	284	1200	85	61.6	45.9	650	Belt	FPM, EPDM

<sup>1</sup> Selection of an optional seal requires a suffix addition to the base model number. For more information see page 4.



Dedicated Engineering and advanced Research & Development teams take new product designs from feasibility to reality using the latest design and testing technologies. New products and other production parts are life tested to ensure they meet Cat Pumps' rigorous quality standards.

# Plunger Pumps

## 316 STAINLESS STEEL MANIFOLDS



2SF25SEEL



271  
(Rails and shaft protector sold separately)



781  
(Rails sold separately)

PUMP MODEL	MAXIMUM FLOW		MAXIMUM PRESSURE		HORSEPOWER		RPM	DRIVES	OPTIONAL SEALS
	GPM	LPM	PSI	BAR	HP	KW			
<b>316 STAINLESS STEEL MANIFOLDS WITH BUNA SEALS 0.5 TO 6 GPM (1.9 TO 23 LPM)</b>									
Note: Models ending in the letter "C" or "K" are flush style pumps.									
2SF05SEEL	0.5	1.9	1200	85	0.4	0.3	1725	Hollow shaft-electric	FPM, EPDM, IPFE
2SF10SEEL	1	3.8	1200	85	0.8	0.6	1725	Hollow shaft-electric	FPM, EPDM, IPFE
2SF15SEEL	1.5	5.7	1200	85	1.2	0.9	1725	Hollow shaft-electric	FPM, EPDM, IPFE
2SF22SEEL	2.2	8.3	1200	85	1.8	1.3	1725	Hollow shaft-electric	FPM, EPDM, IPFE
231	2.3	8.7	1500	105	2.4	1.8	1725	Solid shaft, Belt, Bell, Clutch	FPM, EPDM, IPFE, STHT, HT
3CP1231	2.3	8.7	2000	140	3.2	2.4	1725	Solid shaft, Belt, Bell, Clutch	FPM, EPDM, IPFE, HT, ST4
2SF25SEEL	2.5	9.5	1200	85	2.1	1.5	1725	Hollow shaft-electric	FPM, EPDM, IPFE
2SF29SEEL	2.85	10.8	1200	85	2.3	1.7	1725	Hollow shaft-electric	FPM, EPDM, IPFE
2SF35SEEL	3.5	13.2	1200	85	2.9	2.1	1725	Hollow shaft-electric	FPM, EPDM, IPFE
271	3.5	13.2	1500	105	3.6	2.7	1420	Belt, Bell, Clutch	FPM, EPDM, IPFE, STHT, HT
241	3.6	13.6	1200	85	3	2.2	1725	Solid shaft, Belt, Bell, Clutch	FPM, EPDM, IPFE, STHT, HT
3CP1241	3.6	13.6	2000	140	4.9	3.7	1725	Solid shaft, Belt, Bell, Clutch	FPM, EPDM, IPFE, HT, ST4
341	4	15	1800	125	5	3.7	1725	Solid shaft, Belt, Bell, Clutch	FPM, EPDM, IPFE, HT
5CP6241CS	4	15	2000	140	5.5	4.1	1725	Solid shaft, Belt, Bell, Clutch	FPM, EPDM, HT, ST4
311	4	15	2200	155	6	4.5	950	Belt, Clutch	FPM, EPDM, IPFE, HT
311C	4	15	2200	155	6	4.5	950	Belt, Clutch	FPM, EPDM, IPFE, HT
2SF42SEEL	4.2	15.9	1000	70	2.9	2.1	1725	Hollow shaft-electric	FPM, EPDM, IPFE
3CP1221	4.2	15.9	2000	140	5.8	4.3	1725	Solid shaft, Belt, Bell, Clutch	FPM, EPDM, IPFE, HT, ST4
781	4.5	17	5000	345	15.4	11.5	1700	Belt, Clutch	FPM, EPDM, IPFE, PTFE
781K	4.5	17	5000	345	15.4	11.5	1700	Belt, Clutch	FPM, EPDM, IPFE, PTFE
351	5	19	1500	105	5.1	3.8	1725	Solid shaft, Belt, Bell, Clutch	FPM, EPDM, IPFE, HT
5CP6251	5	19	2000	140	6.8	5.1	1725	Solid shaft, Belt, Bell, Clutch	FPM, EPDM, HT, ST4
5CP6221	6	23	2000	140	8.2	6.1	1400	Belt, Clutch	FPM, EPDM, HT, ST4

<sup>1</sup> Selection of an optional seal requires a suffix addition to the base model number. For more information see page 4.

“The rugged durability of Cat Pumps can withstand the corrosive environment in which they are subjected and they have proven to be true workhorses in the desalination field.”

# Plunger Pumps

## 316 STAINLESS STEEL MANIFOLDS



1051  
(Rails and shaft protector sold separately)



1541  
(Rails and shaft protector sold separately)



7CP6111  
(Rails sold separately)

PUMP MODEL	MAXIMUM FLOW		MAXIMUM PRESSURE		HORSEPOWER		RPM	DRIVES	OPTIONAL <sup>1</sup> SEALS
	GPM	LPM	PSI	BAR	HP	KW			
<b>316 STAINLESS STEEL MANIFOLDS WITH BUNA SEALS 9 TO 21 GPM (34 TO 79 LPM)</b>									
Note: Models ending in the letter "C" or "K" are flush style pumps. Pumps in <i>italics</i> indicate an optional performance rating.									
3801	9	34	5000	345	30.8	23	824	Belt	FPM, EPDM
3801K	9	34	5000	345	30.8	23	824	Belt	FPM, EPDM
7CP6111G1	10	38	2000	140	13.7	10.2	1667	Gearbox	FPM, EPDM, STHT
1051	10	38	2200	155	15.1	11.3	958	Belt, Clutch	FPM, EPDM, STHT, NBRS, IPFE, ST4, PTFE
1051C	10	38	2200	155	15.1	11.3	958	Belt, Clutch	FPM, EPDM, STHT, NBRS, IPFE, ST4, PTFE
1861	10	38	3000	210	20.6	15.4	1429	Belt, Clutch	FPM, EPDM, IPFE
1861K	10	38	3000	210	20.6	15.4	1429	Belt, Clutch	FPM, EPDM, IPFE
7CP6111	10.5	40	2000	140	14.4	10.7	1725	Belt, Bell, Clutch	FPM, EPDM, STHT
7CP6171	10.5	40	2000	140	14.4	10.7	1450	Belt, Clutch	FPM, EPDM, STHT
<i>1051</i>	<i>12</i>	<i>45</i>	<i>1800</i>	<i>125</i>	<i>14.8</i>	<i>11</i>	<i>1150</i>	<i>Belt, Clutch</i>	<i>FPM, EPDM, STHT, IPFE, ST4 PTFE</i>
3811	14	53	3000	210	28.8	21.5	800	Belt	FPM, EPDM, IPFE
3811K	14	53	3000	210	28.8	21.5	800	Belt	FPM, EPDM, IPFE
6811	15	57	5000	345	51.5	38.4	600	Belt	FPM, EPDM, IPFE
6811K	15	57	5000	345	51.5	38.4	600	Belt	FPM, EPDM, IPFE
6801	15	57	7000	485	51.5	38.4	600	Belt	FPM, EPDM
6801K	15	57	7000	485	51.5	38.4	600	Belt	FPM, EPDM
1531	15.6	59	1500	105	16	11.9	1450	Belt, Clutch	FPM, EPDM, IPFE
1541	18	68	1200	85	14.7	11	1100	Belt, Clutch	ST4
2511	20	76	1500	105	20.6	15.4	1450	Belt	FPM, STHT, IPFE
2531	<i>21</i>	<i>79</i>	<i>1200</i>	<i>85</i>	<i>17.3</i>	<i>12.9</i>	<i>860</i>	<i>Belt</i>	<i>FPM, EPDM, IPFE, ST4</i>
2831	21	79	1200	85	17.3	12.9	860	Belt	FPM, EPDM
2831K	21	79	1200	85	17.3	12.9	860	Belt	FPM, EPDM

<sup>1</sup> Selection of an optional seal requires a suffix addition to the base model number. For more information see page 4.



**Need more detail?**

Find Product Data Sheets online at [catpumps.com](http://catpumps.com)





2531  
(Rails and shaft protector sold separately)



3531  
(Rails sold separately)



6841

PUMP MODEL	MAXIMUM FLOW		MAXIMUM PRESSURE		HORSEPOWER		RPM	DRIVES	OPTIONAL <sup>1</sup> SEALS
	GPM	LPM	PSI	BAR	HP	KW			
<b>316 STAINLESS STEEL MANIFOLDS WITH BUNA SEALS 23 TO 75 GPM (87 TO 284 LPM)</b>									
Note: Models ending in the letter "C" or "K" are flush style pumps. * Intermittent Duty Only.									
3521	23	87	2000	140	31.6	23.6	800	Belt	FPM, EPDM, IPFE
3521C	23	87	2000	140	31.6	23.6	800	Belt	FPM, EPDM, IPFE
3821	23	87	2000	140	31.6	23.6	800	Belt	FPM, EPDM
3821K	23	87	2000	140	31.6	23.6	800	Belt	FPM, EPDM
2531	25	95	1000	70	17.1	12.8	1025	Belt	FPM, EPDM, IPFE, ST4
6821	25	95	3000	210	51.4	38.3	615	Belt	FPM, EPDM
6821K	25	95	3000	210	51.4	38.3	615	Belt	FPM, EPDM
3531	36	136	1200	85	29.7	22.1	800	Belt	FPM, EPDM, IPFE
3531C	36	136	1200	85	29.7	22.1	800	Belt	FPM, EPDM, IPFE
3831	36	136	1200	85	29.7	22.1	800	Belt	FPM, EPDM, IPFE
3831K	36	136	1200	85	29.7	22.1	800	Belt	FPM, EPDM, IPFE
3531HS*	40	151	1750	121	47.9	35.8	888	Belt	FPM, EPDM, IPFE
6831	40	151	2300	160	63	47	625	Belt	FPM
6831K	40	151	2300	160	63	47	625	Belt	FPM
3541	45	170	1000	70	30.9	23.0	765	Belt	FPM, EPDM, IPFE
3541C	45	170	1000	70	30.9	23.0	765	Belt	FPM, EPDM, IPFE
3841	45	170	1000	70	30.9	23.0	765	Belt	FPM, EPDM, IPFE
3841K	45	170	1000	70	30.9	23.0	765	Belt	FPM, EPDM, IPFE
6841	48	182	2000	140	65.8	49.1	615	Belt	FPM, EPDM
6841K	48	182	2000	140	65.8	49.1	615	Belt	FPM, EPDM
6761	60	227	1200	85	49.4	36.8	520	Belt	FPM, EPDM
6861	60	227	1200	85	49.3	36.8	520	Belt	FPM
6861K	60	227	1200	85	49.3	36.8	520	Belt	FPM
6771	75	284	1200	85	61.6	45.9	650	Belt	FPM, EPDM

**304 STAINLESS STEEL MANIFOLDS WITH BUNA SEALS 3 GPM (11 LPM)**

1810	3	11	10,000	690	20.5	15.3	1500	Belt	Contact Cat Pumps
1810K	3	11	10,000	690	20.5	15.3	1500	Belt	Contact Cat Pumps

<sup>1</sup> Selection of an optional seal requires a suffix addition to the base model number. For more information see page 4.

# Plunger Pumps

## DUPLEX STAINLESS STEEL MANIFOLDS



3511  
(Rails sold separately)



6762



152R100

PUMP MODEL	MAXIMUM FLOW		MAXIMUM PRESSURE		HORSEPOWER		RPM	DRIVES	OPTIONAL <sup>1</sup> SEALS
	GPM	LPM	PSI	BAR	HP	KW			
<b>DUPLEX STAINLESS STEEL MANIFOLDS WITH BUNA SEALS 9 TO 240 GPM (34 TO 908 LPM)</b>									
Note: Models ending in the letter "C" or "K" are flush style pumps.									
3501	9	34	5000	345	30.8	23.0	824	Belt	FPM
3501C	9	34	5000	345	30.8	23.0	824	Belt	FPM
1051D	10	38	2200	155	15.1	11.3	958	Belt, Clutch	FPM, EPDM, STHT, NBRs, IPFE, ST4, PTFE
661C	10	38	3000	210	20.6	15.4	1429	Belt, Clutch	FPM, EPDM, IPFE
661D	10	38	3000	210	20.6	15.4	1429	Belt, Clutch	FPM, EPDM, IPFE
3511	14	53	3000	210	28.8	21.5	800	Belt	FPM, IPFE
3511C	14	53	3000	210	28.8	21.5	800	Belt	FPM, IPFE
3822	23	87	2000	140	31.6	23.6	800	Belt	Contact Cat Pumps
3832	36	136	1200	85	29.7	22.1	800	Belt	Contact Cat Pumps
6762	60	227	1200	85	49.4	36.8	520	Belt	FPM
6862	60	227	1200	85	49.3	36.8	520	Belt	Contact Cat Pumps
6864	60	227	1200	85	49.3	36.8	520	Belt	Contact Cat Pumps
157R060	100	379	2700	190	184.9	138	310	Belt	FPM
152R060	115	435	1200	85	94.5	70	360	Belt	FPM
152R060C	115	435	1200	85	94.5	70.5	360	Belt	FPM
152R080	200	757	1200	85	164.4	122.6	355	Belt	FPM, EPDM
152R080C	200	757	1200	85	164.4	122.6	355	Belt	FPM, EPDM
157R080	200	757	1560	108	213.7	159.4	355	Belt	FPM
152R100	240	908	1000	70	164.4	122.6	270	Belt	FPM
152R100C	240	908	1000	70	164.4	122.6	270	Belt	FPM

<sup>1</sup> Selection of an optional seal requires a suffix addition to the base model number. For more information see page 4.

“In our business, downtime means delays and lost productivity. We use only Cat Pumps on all of our cleaning equipment because in our business, reliability and dependability are the keys to our success.”

Chris Keating • Power Clean

# Piston Pumps

## BRASS AND STAINLESS STEEL MANIFOLDS

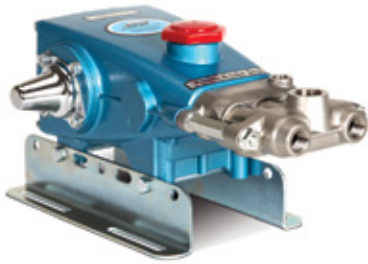

280  
(Rails and shaft protector sold separately)

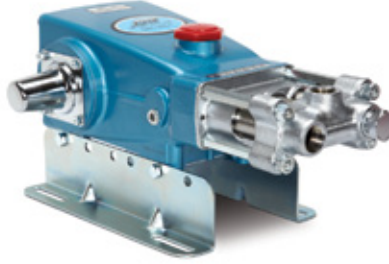

820  
(Rails and shaft protector sold separately)



2520  
(Rails and shaft protector sold separately)

PUMP MODEL	MAXIMUM FLOW		MAXIMUM PRESSURE		HORSEPOWER		RPM	OPTIONAL <sup>1</sup> SEALS
	GPM	LPM	PSI	BAR	HP	KW		
<b>BRASS MANIFOLDS WITH BUNA SEALS 3 TO 60 GPM (11.4 TO 227 LPM)</b>								
Note: Models ending in the letter "C" or "K" are flush style pumps.								
280	3	11.4	1000	70	2.1	1.6	1330	FPM, PTFE, HT
290	3.5	13.2	1200	85	2.9	2.2	1200	FPM, PTFE, HT
333	4	15	1200	85	3.3	2.5	1070	FPM, PTFE, BNG, HT
430	5	19	1000	70	3.4	2.5	1040	FPM, PTFE, BNG, HT
323	5	19	1500	105	5.1	3.8	1000	FPM, BNG
623	6	23	1200	85	4.9	3.7	850	FPM, BNG, HT
820	10	38	1000	70	6.9	5.1	940	FPM, BNG, HT
390	12	45	600	40	4.9	3.7	1200	FPM, HT
1010	13	49	700	50	6.2	4.6	900	FPM, BNG, HT
2520	25	95	800	55	13.7	10.2	772	FPM, HT
2520C	25	95	800	55	13.7	10.2	772	FPM, HT
6040	40	151	1500	105	41.1	30.6	500	FPM
6020	60	227	1000	70	41.1	30.6	500	FPM, PTFE

### 316 STAINLESS STEEL MANIFOLD WITH BUNA SEALS 3 TO 60 GPM (11.4 TO 227 LPM)

Note: Internal components are chrome plated 304 stainless steel.

281	3	11.4	1000	70	2.1	1.6	1330	FPM, PTFE, HT
291	3.5	13.2	1200	85	2.9	2.2	1200	FPM, PTFE, HT
331	4	15	1200	85	3.3	2.5	1070	FPM, PTFE, BNG, HT
431	5	19	1000	70	3.4	2.5	1040	FPM, PTFE, BNG, HT
621	6	23	1200	85	4.9	3.7	850	FPM, BNG, HT
821	10	38	1000	70	6.9	5.1	940	FPM, BNG, HT
1011	13	49	700	50	6.2	4.6	900	FPM, BNG, HT
2521	25	95	800	55	13.7	10.2	772	FPM, HT
6041	40	151	1500	105	41.1	30.6	500	FPM
6021	60	227	1000	70	41.1	30.6	500	FPM, PTFE

<sup>1</sup> Selection of an optional seal requires a suffix addition to the base model number. For more information see page 4.

**Need more detail?**

Find Product Data Sheets online at [catpumps.com](http://catpumps.com)

# Centrifugal Pumps

## 304 STAINLESS STEEL CASING

These centrifugal pumps offer solutions for high-flow, low-pressure industrial pumping needs. Typical fluids pumped include fresh water, semi-dirty water or liquids with some suspended solids. Below is a sampling of popular centrifugal models that include the pump, seal and motor. Most of the pumps listed are rated at 3450 rpm, but many models are available at 1725 rpm.



PUMP MODEL	MAXIMUM FLOW		MAXIMUM PRESSURE		HORSEPOWER		PHASE/VOLTAGE
	GPM	LPM	PSI	BAR	HP	KW	

### Submersible Pumps with Integral Motor and Seal\*

#### 45 TO 100 GPM (170 TO 379 LPM)

1K100	45	170	10	0.69	0.3	0.2	1PH / 115V**
1K201	73	276	17	1.17	0.5	0.4	1PH / 115V**
1K203	73	276	17	1.17	0.5	0.4	1PH / 115V***
1K205	73	276	17	1.17	0.5	0.4	3PH / 460V***
1K301	74	280	21	1.45	0.8	0.6	1PH / 115V**
1K303	74	280	21	1.45	0.8	0.6	1PH / 115V***
1K305	74	280	21	1.45	0.8	0.6	3PH / 460V***
2K102	88	333	9	0.62	0.5	0.4	1PH / 230V***
2K103	88	333	9	0.62	0.5	0.4	1PH / 230V**
2K200	100	379	11	0.76	1.0	0.7	1PH / 115V**
2K202	100	379	11	0.76	1.0	0.7	1PH / 230V**

\*Motor side seal is NBR fitted Carbon/Ceramic and impeller side seal is Viton® fitted Silicon Carbide/Silicone Carbide.

\*\*Supplied with automatic float switch

\*\*\*Manual models, no float switch

### End-Suction Motorized Units with TEFC 56J NEMA Motor

#### 38 TO 63 GPM (144 TO 238 LPM)

3K132WT0	38	144	62	4.3	2.0	1.5	1PH / 115/208-230V
3K132WT3	38	144	62	4.3	2.0	1.5	3PH / 208-230/460V
3K392BT3	52	197	13	0.9	0.5	0.4	3PH / 208-230/460V
3K142WT0	63	238	32	2.2	1.0	0.7	1PH / 115/208-230V
3K142WT3	63	238	32	2.2	1.0	0.7	3PH / 208-230/460V
3K152WT0	63	238	44	3.0	1.5	1.1	1PH / 115/208-230V
3K152WT3	63	238	44	3.0	1.5	1.1	3PH / 208-230/460V
3K162WT3	63	238	63	4.3	3.0	2.2	3PH / 208-230/460V

Note: All motors are rated at 3450 rpm except model 3K392BT3 which is rated at 1725. All models listed are equipped with a Viton®/Carbon/Ceramic chemical resistant seal. Buna and high temperature seals are also available.

### End-Suction Motorized Units with TEFC 213/215JM NEMA Motor

#### 153 TO 380 GPM (579 TO 1,438 LPM)

4K142WT3	153	579	90	6.2	0.5	0.4	3PH / 208-230/460V
4K192WT3	250	946	82	5.7	1.0	0.7	3PH / 208-230/460V
4K252WT3	380	1,438	84	5.8	1.0	0.7	3PH / 208-230/460V

Note: All motors are rated at 3450 rpm. All models listed are equipped with a Viton®/Carbon/Ceramic chemical resistant seal. Buna and high temperature seals are also available.

### Self-Priming Motorized Units with TEFC 56J NEMA Motor

#### 18.5GPM (70 LPM)

5K112WT0	18.5	70	56	3.9	1.0	0.7	1PH / 115/208-230V
5K112WT3	18.5	70	56	3.9	1.0	0.7	3PH / 208-230/460V
5K122WT0	18.5	70	82	5.7	1.0	0.7	1PH / 115/208-230V
5K122WT3	18.5	70	82	5.7	2.0	1.5	3PH / 208-230/460V

Note: All motors are rated at 3450 rpm. All models listed are equipped with a Viton®/Carbon/Ceramic chemical resistant seal. Buna and high temperature seals are also available.



# Accessories

ENSURING MAXIMUM PUMP PERFORMANCE



## Demand Genuine Cat Pump Accessories

Cat Pumps offers a wide range of accessories, with all adhering to the same exacting standards as its pumps. A pumping system's ongoing performance is as good as its weakest component, which is why accessory components are rigorously tested and evaluated. The goal is to provide the best system value by offering pumps and accessories that exceed your performance and reliability expectations, helping you realize the lowest possible life cycle cost.



Check out our complete line of accessories  
online at [catpumps.com](http://catpumps.com)

# Custom Pumping Systems

YOU DEFINE. WE DESIGN AND DELIVER.

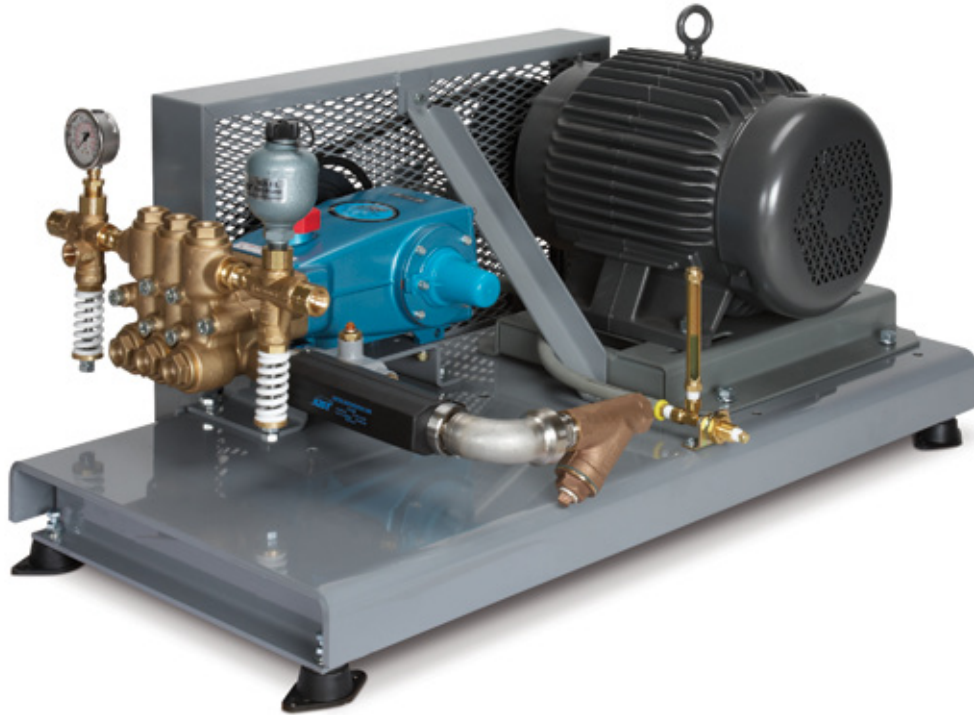

## Custom Engineered to Meet your Application Demands



For over 25 years, Cat Pumps has been the industry leader in providing customers with quality custom-engineered pumping systems to meet a ever-widening range of application needs. By selecting Cat Pumps for your next pumping system, you can eliminate the hassle and expense of designing, multiple source buying, fabrication and testing. The knowledgeable and helpful technical sales team will assist you with proper component selection as well as installation, operation and maintenance support.

All systems are designed, built and pressure tested in Cat Pumps' Minneapolis location, and typically ship in two to eight weeks. To begin the quoting process, call our main office at 763-780-5440, or submit our custom system quote form at [catpumps.com](http://catpumps.com).

With thousands of installations running around the world, choose Cat Pumps for your next custom pumping system.

Call or go online to start your quote today.



## System Configuration

Cat Pumps' skilled technical sales staff has extensive experience in hundreds of applications and will work with you to determine the best configuration for your application. A wide variety of options are offered to fit any installation.

### Base

System design starts with choosing the base that best fits your application. Numerous base configurations are available to meet space, portability, sound and material demands.

- Standard • Vertically Stacked • Portable • Enclosed • Multiple Pump

### Power Source

Evaluate which power source will best fit the needs of your installation. A qualified and proven staff with extensive experience can assist in recommending the correct product for any power source available.

- Electric • Gas • Diesel • Hydraulic • Pneumatic

### Drive Package

A wide variety of drive packages are available to compliment your power source of choice.

- Belt • Direct Drive • Gearbox • Flex Coupling/Bell Housing • Clutch

### Accessories

Choose from hundreds of high-quality genuine Cat Pumps accessories to ensure optimum system performance and life.

- Regulator • Unloader • Relief / Pop-off Valve • Pressure Gauge
- Pulsation Dampener • Captive Acceleration Tube (C.A.T.)
- Inlet Filter / Strainer • Guns • Oil



## Advanced Control Options



Ask about Cat Pumps' wide variety of advanced control options which is designed to help ensure maximum system performance, as well as provide maximum system protection. Some options include:

- Variable Frequency Drives
- PID Loop (varies speed of pump to maintain system pressure)
- Multiple Pump Systems
- Low-Pressure Seal Monitors
- Auto Shutdowns (Temperature and Low Inlet Pressure)

Other control options to suit your application needs are available upon request.

## ABOUT CAT PUMPS

## Proven Quality, Customer Focused

Founded in 1968, Cat Pumps is a world leader in the design, manufacture and marketing of the most dependable high-pressure positive displacement reciprocating triplex pumps and systems in the market.

With an emphasis on immediate product availability and outstanding customer service, the family-owned and operated business prides itself on a commitment to quality and product reliability as the foundation of its ongoing success. It is the mission to exceed customer expectations for quality, reliability, availability, delivery, technical expertise and aftermarket support to assure the best value in all the industries served.

## LOCATIONS

### Worldwide Headquarters

#### Cat Pumps

1681 94th Lane Northeast  
Minneapolis, MN 55449  
USA

P: 763-780-5440  
F: 763-780-2958  
techsupport@catpumps.com  
www.catpumps.com

#### Territories Served

U.S., Canada

#### International Division

P: 763-780-5440  
F: 763-780-2958  
intlsales@catpumps.com  
www.catpumps.com

#### Territories Served

Africa, Asia, Australia, Central and South America, Mexico, Middle East, New Zealand, Turkey

#### Cat Pumps International N.V.

Heiveldekens 6A  
2550 Kontich  
Belgium

P: 32 3 450 71 50  
F: 32 3 450 71 51  
cpi@catpumps.be  
www.catpumps.be

#### Territories Served

Western Europe (except U.K., Germany, and Austria)

#### Cat Pump (U.K.) Ltd.

1 Fleet Business Park, Sandy Lane  
Church Crookham  
FLEET, Hampshire GU52 8BF  
England

P: +44 1252 622031  
F: +44 1252 626655  
sales@catpumps.co.uk  
technical@catpumps.co.uk  
www.catpumps.co.uk

#### Territories Served

England, Ireland, Scotland,  
N. Ireland, Wales

#### Cat Pumps Deutschland GmbH

Buchwiesse 2, D-65510  
Idstein  
Germany

P: +49 6126 9303 0  
F: +49 6126 9303 33  
catpumps@t-online.de  
www.catpumps.de

#### Territories Served

Austria, Commonwealth of Independent States (CIS), Germany and Eastern Europe

## SALES, DISTRIBUTION, SERVICE

Call today for product and application assistance.

763-780-5440 or visit us at [www.catpumps.com](http://www.catpumps.com)



#### CAT PUMPS

1681 - 94TH LANE N.E. MINNEAPOLIS, MN 55449-4324  
PHONE (763) 780-5440 — FAX (763) 780-2958  
e-mail: techsupport@catpumps.com  
www.catpumps.com

For International inquiries go to [www.catpumps.com](http://www.catpumps.com) and navigate to the "Contact Us" link.

©2012 Cat Pumps Inc. All rights reserved. All written and visual data contained in this document are based on the latest product information available at the time of publication. Cat Pumps reserves the right to make changes at any time without notice. All other brand names or marks are used for identification purposes and are trademarks of their respective owners.